

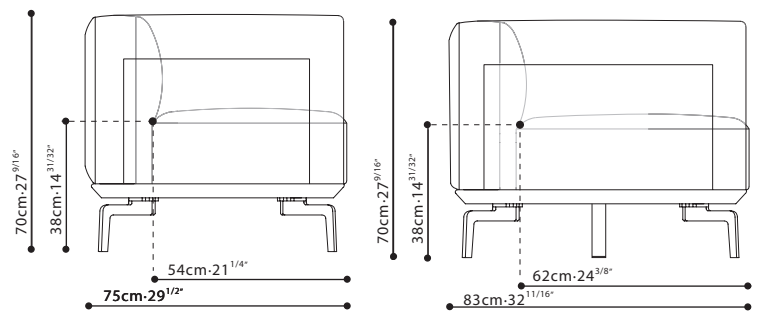

AVALON / FRAME: Exterior steel panels covered in P/FC eco-leather. SEAT/ARMS/BACK: Removable cushions filled w/feather wrapped high-resilient foam core. BASE: FC-11 black eco-leather wrapped steel frame w/cross-woven elastic webbing & sinuous springs. FEET: Black metallic painted steel w/plastic glides. UPHOLSTERY: Removable fabric, leather or fabric/leather combo. Exterior panels in complimenting P/FC eco-leather; Q & R/RS leather available w/up charge.

Sofa Connectors NOT Available



(for C01A0701 only)

FABRIC VERSION

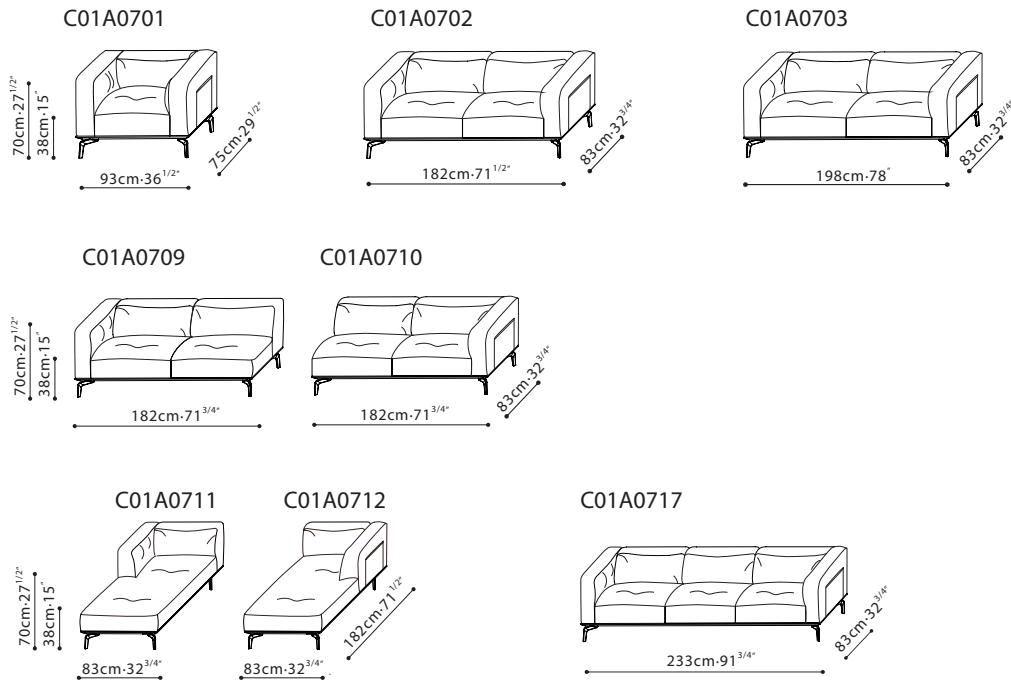

LEATHER VERSION

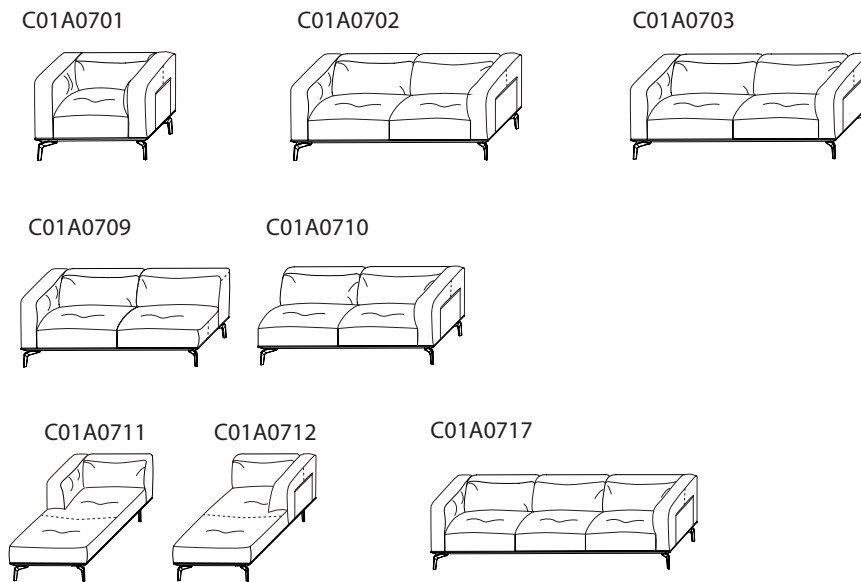

(dotted lines illustrate positioning of stitched seams on leather versions of this sofa)

SAMPLE CONFIGURATION

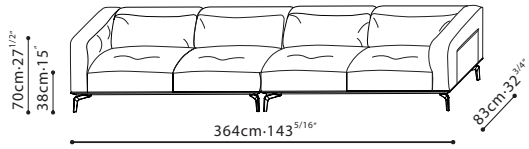

C01A0709+C01A0710

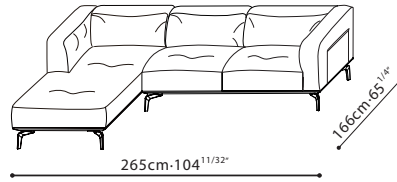

C01A0707+C01A0710

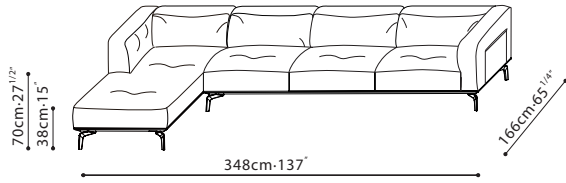

C01A0707+C01A0714

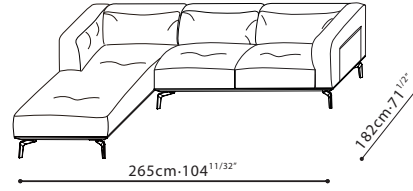

C01A0711+C01A0710

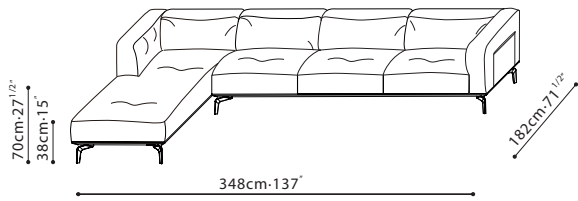

C01A0711+C01A0714

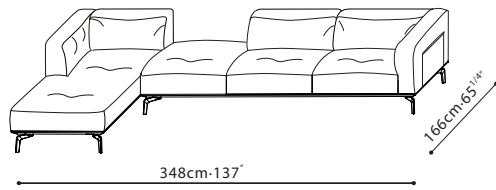

C01A0707+C01A0715

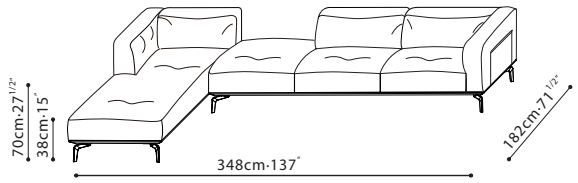

C01A0711+C01A0715

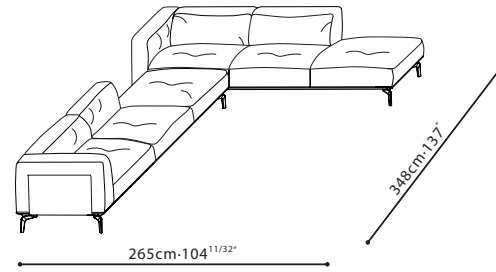

C01A0716+C01A0716