

# Meridien

design by Stefano Spessotto

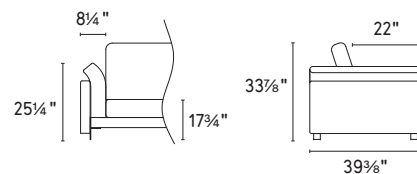

## CS3411



This item can be ordered only via e-mail

Technical specifications  
see page 96



FABRIC	Frame	Seat cushions	Backrest cushions	Armrest cushions
Removable	●	●	●	●
Not removable	-	-	-	-

LEATHER / BEDFORD	Frame	Seat cushions	Backrest cushions	Armrest cushions
Removable	-	●	●	●
Not removable	●	-	-	-

**MODULARITY:** All the modular elements are designed to be placed side by side. For any request for products that are free standing, shaped and finished on the sides, please contact the Sales Dept. to verify feasibility and prices.

## FOOT



**Metal**  
Matt black P15

## NOTES

1. Throw pillows are not included in the model.
2. Coordinated ottoman available.

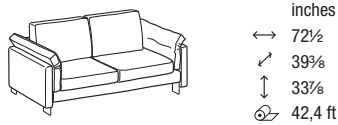

**DTD200G**  
2-ER MAXI SOFA

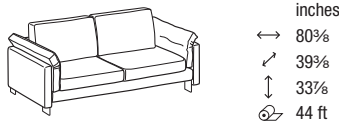

**DTD3000**  
3-ER SOFA

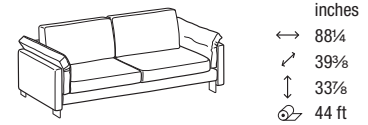

**DTD300M**  
3-ER MAXI SOFA

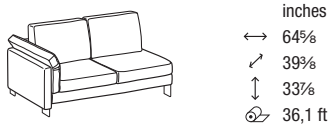

**DTL200GS - DTL200GD**  
2-ER MAXI LATERAL ELEMENT



**DTL3000S - DTL3000D**  
3-ER LATERAL ELEMENT

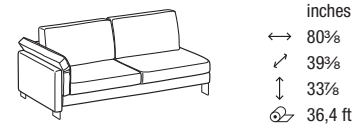

**DTL300MS - DTL300MD**  
3-ER MAXI LATERAL ELEMENT

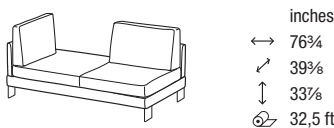

**DTD3D00S - DTD3D00D**  
DAY BED



**DTA1Q00**  
SQUARE CORNER ELEMENT



**DTC1000**  
1-ER CENTRAL ELEMENT



**DTH2000S - DTH2000D**  
CHAISE LONGUE



**DTH200MS - DTH200MD**  
MAXI CHAISE LONGUE

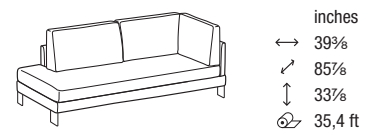

**DTL3A00S - DTL3A00D**  
LATERAL CORNER ELEMENT



**DTU1000**  
OTTOMAN

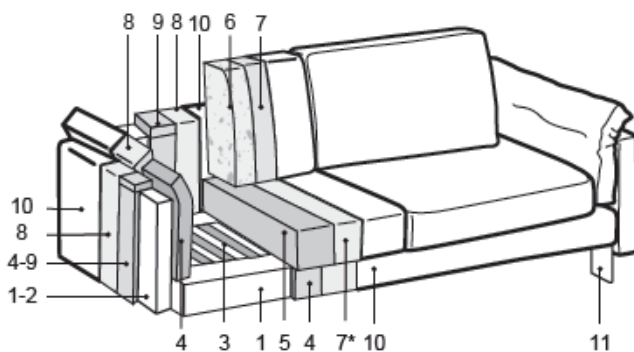

1. Solid wood
2. Chipboard panel
3. Propylene elastic belts
4. Polyurethane foam D21
5. Soft polyurethane foam D35
6. Feather Mix
7. Cotton canvas or Resin and Velveteen cover\*
8. Cover in velveteen and synthetic fiber
9. Polyurethane foam D40
10. Cover
11. Metal foot