

Storage units **Abaco**

Technical features

MODULARITY

heights

(excluding feet and base support)

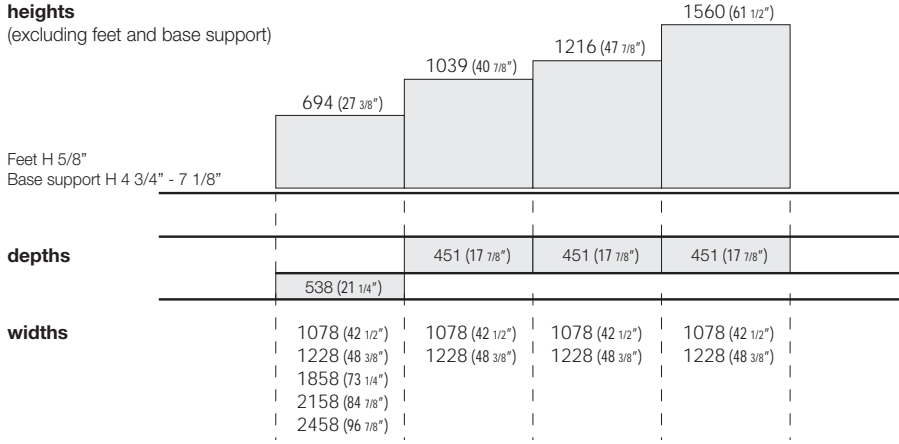

PRODUCT DATA SHEET

STRUCTURE, FRONTS and TOP in *wood particle board panels thickness 7/8" with 45°-shaped vertical edges and coated con synthetic melamine matt lacquered or metal or with painted wood veneer. Internal shelves in transparent tempered glass thickness 1/4".

BACK PANELS in medium density *wood particle board panels thickness 1/4" with synthetic melamine also matt lacquered or metal (possible combinations at page 124).

TURN DRAWER thickness 5/8" and BOTTOM thickness 3/8" in *wood particle board panels with melamine Juta-effect.

HORIZONTAL PARTITIONS in medium density *wood particle board panels thickness 1/2" with synthetic melamine matt lacquered or metal or coated in wood veneer.

Black ABS FEET, diam. 1 7/8" and height 5/8" adjustable form the inside.

SOSPENDO BASE SUPPORT consisting of black metal frame with cylindrical height adjustable feet finished with epoxy or liquid painting.

*Wood and derivates components according to the following standards: EPA TSCA TITLE VI.

RUNNERS FOR DRAWERS

Opening with grip: High sliding full extraction metal runners with FULL EXTRACTION, end-of-run buffer with dynamic capacity of 30 kg. "Blumotion" soft-closing mechanism integrated in the runner for a silence and soft closing system.. Anti-tilting pin, vertical and inclination adjustment of fronts incorporated in all system runners. Additional stabilizer bar for drawers width 29 1/8" and 35 1/8" and "MOVENTO" runners with built-in stabilizer and also front side adjustment for drawers width 46 7/8".

OPENINGS



STRUCTURAL FEATURES

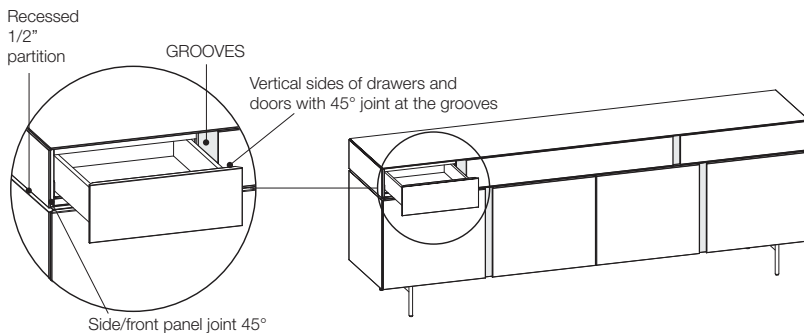

GROOVES

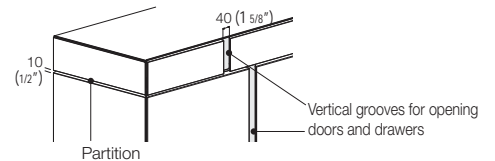

EXPLODED VIEW

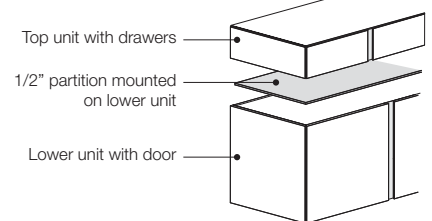

Storage units **Abaco**

Technical features

FLOOR-STANDING SIDEBOARDS (foot H 5/8")

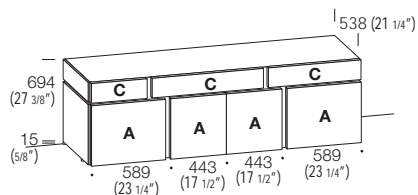

SIDEBOARD WITH SOSPENDO BASE SUPPORT

Sideboards are delivered with metal antifix base support and feet.

Abaco sideboard

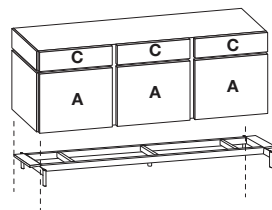

System **Sospendo**

Metal base support complete with feet

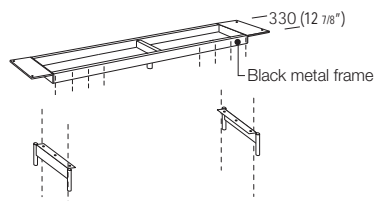

Pair of feet Sospendo	
C2 C3 Epoxy Metal - Brown - Piombo	C2 C3 Painted metal - Bronzo - Ottone - Rame

W m³ CODE

41 3/8"	0,02	CNLC10	244	292
47 1/4"	0,03	CNLC12	251	299
70 7/8"	0,04	CNLC18	278	326
82 3/4"	0,05	CNLC21	294	342
94 1/2"	0,05	CNLC24	308	356

W Bar W BASE SUPPORT W m³ CODE Price per pc

EXTERNAL LIGHTING UNDER BASE SUPPORT WITH 3000K LED BARS
External profile in satin-finish aluminium W 1/2" x H 1/2" with opal plastic casing, complete with power supply with optional remote control.

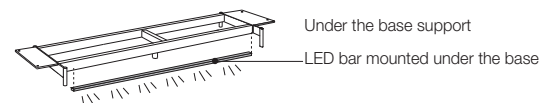

17 3/4"	41 3/8"	5,4	0,01	NYK045	53
23 5/8"	47 1/4"	7,2	0,01	NYK060	62
47 1/4"	70 7/8"	14,4	0,01	NYK120	95
47 1/4"	82 3/4"	14,4	0,01	NYK120	95
70 7/8"	94 1/2"	21,6	0,01	NYK180	133

Power supply included in the price of led bar.

Switch of light with connection to mains supply or remote control.

RADIO FREQUENCY REMOTE CONTROL FOR SWITCHING ON-OFF

Remote control kit with on/off system that supports power supplies for LED lights up to max. 300 W. It can be used on all illumination systems by placing the kit with receiver before the control gear. (in the event that more than one power supply is used, use a multi-socket power strip)

Remote control	NHT012	110
----------------	--------	-----

Remote control Ø 1 5/8"

