

Modularity of base/wall units

For sideboards and TV Unit **Cabaret - Incontro - Lampo - Scrigno**

MODULARITY

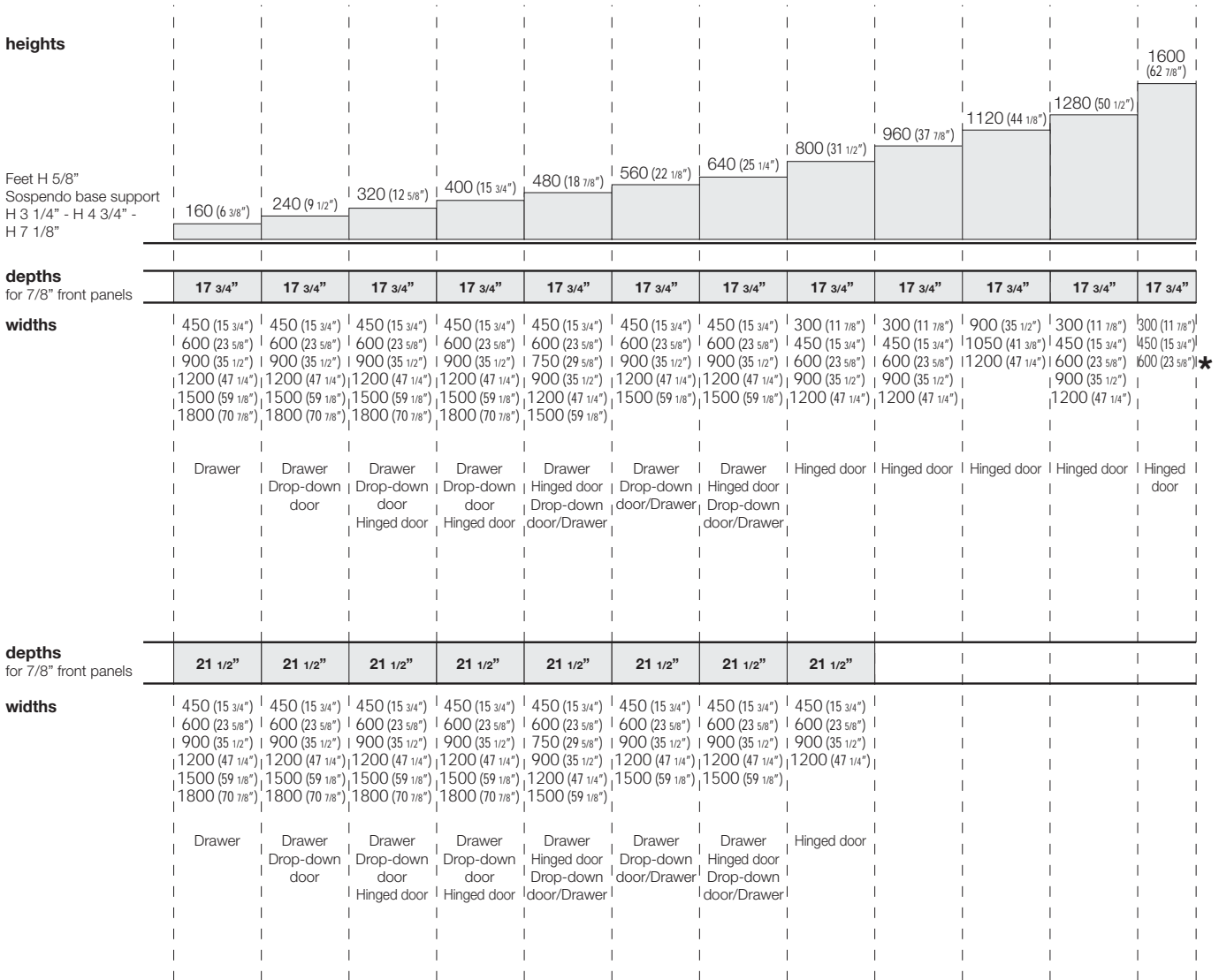



* For width 23 5/8" only available depth 17 3/4" with fronts th. 7/8"

Structural features modular units

For sideboards and TV Unit **Cabaret - Incontro - Lampo - Scrigno**

STRUCTURES for hinged doors H 12 5/8" - 15 3/4"

1 door	D W	2 doors * with anti-flection bar	D W	2 doors with internal partition for hanging unit with 3 hangers	D W
	<u>21 1/2" 17 3/4"-23 5/8"</u> <u>17 3/4" 17 3/4"-23 5/8"</u>		<u>* 21 1/2" 35 1/2"</u> <u>* 17 3/4" 35 1/2"</u>	 Partition thickness 1 5/8"	<u>21 1/2" 47 1/4"</u> <u>17 3/4" 47 1/4"</u>

inner shelves upon request

STRUCTURES for hinged doors H 18 7/8" - 22 1/8" - 25 1/4" - 31 1/2"

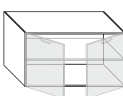
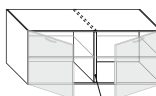
1 door	D W	2 doors * with anti-flection bar	D W	2 doors with internal partition for hanging unit with 3 hangers	D W
	<u>21 1/2" 17 3/4"-23 5/8"</u> <u>17 3/4" 17 3/4"-23 5/8"</u>		<u>* 21 1/2" 35 1/2"</u> <u>* 17 3/4" 35 1/2"</u>	 Partition thickness 1 5/8"	<u>21 1/2" 47 1/4"</u> <u>17 3/4" 47 1/4"</u>
1 glass shelf		1 glass shelf		2 glass shelves	

STRUCTURES for hinged doors H 62 7/8"

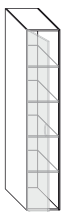

1 door	D W
	<u>17 3/4" 11 7/8"-</u> <u>17 3/4"-23 5/8"*</u>

4 glass shelves

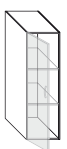
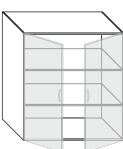
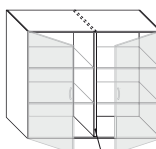
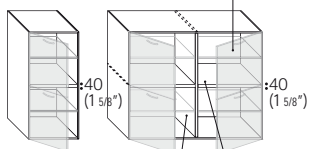
STRUCTURES for hinged doors H 37 7/8"

1 door	D W	2 doors	D W	2 doors for hanging unit with 3 hangers	D W	Divided doors for hanging unit with 3 hangers Glass shelf
	<u>17 3/4" 11 7/8"-</u> <u>17 3/4"-23 5/8"</u>		<u>17 3/4" 35 1/2"</u>	 Partition thickness 1 5/8"	<u>17 3/4" 47 1/4"</u>	 :40 (1 5/8") Partition thickness 1 5/8" Wooden shelf thickness 1 5/8"
2 glass shelves		2 glass shelves		4 glass shelves		2 glass shelves 4 glass shelves

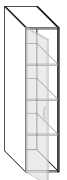
STRUCTURES for hinged doors H 50 1/2"

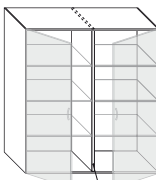
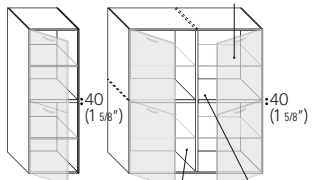
1 door	D W	2 doors	D W	2 doors for hanging unit with 3 hangers	D W	Divided doors for hanging unit with 3 hangers Glass shelf
	<u>17 3/4" 11 7/8"-</u> <u>17 3/4"-23 5/8"</u>		<u>17 3/4" 35 1/2"</u>	 Partition thickness 1 5/8"	<u>17 3/4" 47 1/4"</u>	 :40 (1 5/8") Partition thickness 1 5/8" Wooden shelf thickness 1 5/8"
3 glass shelves		3 glass shelves		6 glass shelves		2 glass shelves 4 glass shelves

Structural features modular units

For sideboards and TV Unit **Cabaret - Incontro - Lampo - Scrigno**

STRUCTURES for drop-down/ lift-up doors H 9 1/2"/12 5/8"/15 3/4"

1 drop-down door	D	W
	21 1/2"	23 5/8"-35 1/2"
	17 3/4"	23 5/8"-35 1/2"

inner shelves upon request

1 drop-down door with internal partition	D	W
	21 1/2"	47 1/4"-59 1/8"-70 7/8"
Partition thickness 1 5/8" recessed	17 3/4"	47 1/4"-59 1/8"-70 7/8"

STRUCTURES for drawers

1 drawer	D	W	H 6 3/8" 1 drawer
	21 1/2"	17 3/4"-23 5/8"-35 1/2"	H 9 1/2" 1 drawer
	17 3/4"	17 3/4"-23 5/8"-35 1/2"	H 12 5/8" 1 deep drawer H 12 5/8"
			2 drawers H 6 3/8"
			H 15 3/4" 1 deep drawer H 15 3/4"
			1 drawer H 6 3/8" + 1 drawer H 9 1/2"

1 drawer with internal partition and double turn drawer	D	W	H 18 7/8" 1 drawer H 6 3/8" + 1 drop-down door H 12 5/8"
	21 1/2"	47 1/4"-59 1/8"	2 drawers H 9 1/2"
Partition thickness 1 5/8"	17 3/4"	47 1/4"-59 1/8"	3 drawers H 6 3/8"
			H 22 1/8" 2 drawers H 6 3/8" + 1 drawer H 9 1/2"
			H 25 1/4" 4 drawers H 6 3/8"
			2 drawers H 6 3/8" + 1 drop-down door H 12 5/8"
			1 drawer H 6 3/8" + 2 drawers H 9 1/2"
			1 drawer H 12 5/8" + 1 drop-down door H 12 5/8"
			1 drawer H 9 1/2" + 1 drop-down door H 15 3/4"

RUNNERS FOR DRAWERS

Push-pull opening: High sliding full extraction metal runners with FULL EXTRACTION, end-of-run buffer with dynamic capacity of 30 kg. Integrated sliding synchronizer in drawer runners wider than 17 3/4". Anti-tilting pin, vertical and inclination adjustment of fronts incorporated in all system runners. Drawers width 47 1/4" and 59 1/8" with "MOVENTO" runners and side adjustment of fronts.

Opening with grip: High sliding full extraction metal runners with FULL EXTRACTION, end-of-run buffer with dynamic capacity of 30 kg. "Blumotion" soft-closing mechanism integrated in the runner for a silence and soft closing system.. Anti-tilting pin, vertical and inclination adjustment of fronts incorporated in all system runners. Additional stabilizer bar for drawers width 35 1/2" and "MOVENTO" runners with built-in stabilizer and also front side adjustment for drawers width 47 1/4" and 59 1/8".

DRAWER UNITS ARE DELIVERED WITH A NON-TILTING DEPTH ADJUSTMENT BRACKET TO BE FIXED TO THE WALL.

Structural features modular units with composed fronts

- C** Drawer
- A** Door
- R** Drop-down

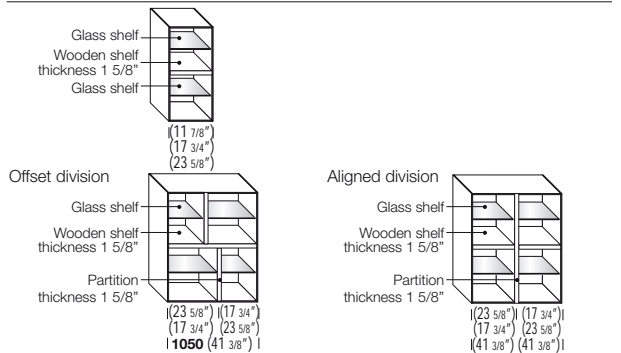
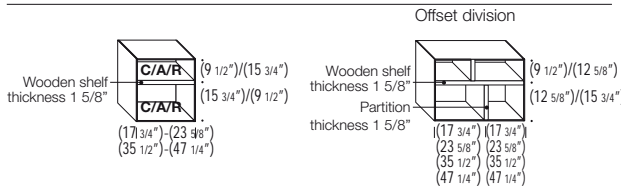

H Units	WOODEN DOORS FINISH thickness 7/8" - 1 3/8"	WOODEN FLAP DOORS thickness 7/8" - 1 3/8"	WOODEN DRAWERS thickness 7/8" - 1 3/8"
25 1/4"	W 17 3/4" 23 5/8" (11 7/8" + 11 7/8") 29 5/8" (11 7/8" + 17 3/4") 35 1/2" (11 7/8" + 23 5/8") 35 1/2" (17 3/4" + 17 3/4") H 12 5/8" - 15 3/4" - 25 1/4"	W 35 1/2" - 47 1/4" H 12 5/8" - 15 3/4"	W 17 3/4" - 23 5/8" - 35 1/2" - 47 1/4" H 6 3/8" - 9 1/2" - 12 5/8"
31 1/2"	W 11 7/8" - 17 3/4" - 23 5/8" - 29 5/8" (17 3/4" + 11 7/8") 35 1/2" (23 5/8" + 11 7/8") / 17 3/4" + 17 3/4" / 41 3/8" (23 5/8" + 17 3/4") H 15 3/4"	Scrigno GLASS DOOR thickness 1 3/8" applicable (1 3/8") / (1 3/8")	Not applicable
37 7/8"	W 11 7/8" - 17 3/4" - 23 5/8" - 29 5/8" (17 3/4" + 11 7/8") 35 1/2" (23 5/8" + 11 7/8") / 17 3/4" + 17 3/4" / 41 3/8" (23 5/8" + 17 3/4") H 18 7/8"	W 17 3/4" - 23 5/8"	H 18 7/8"
44 1/8"	W 11 7/8" - 17 3/4" - 23 5/8" - 29 5/8" (17 3/4" + 11 7/8") 35 1/2" (23 5/8" + 11 7/8") / 17 3/4" + 17 3/4" / 41 3/8" (23 5/8" + 17 3/4") H 15 3/4" - 18 7/8" - 25 1/4"	W 17 3/4" - 23 5/8"	H 18 7/8" - 25 1/4"
47 1/4"	W 17 3/4" - 35 1/2" H 15 3/4"	Not applicable	Not applicable
50 1/2"	W 11 7/8" - 17 3/4" - 23 5/8" - 29 5/8" (17 3/4" + 11 7/8") 35 1/2" (23 5/8" + 11 7/8") / 17 3/4" + 17 3/4" / 41 3/8" (23 5/8" + 17 3/4") H 18 7/8" - 25 1/4" - 31 1/2"	W 17 3/4" - 23 5/8"	H 18 7/8" - 25 1/4"
62 7/8"	W 11 7/8" - 17 3/4" - 23 5/8" - 29 5/8" (17 3/4" + 11 7/8") 35 1/2" (23 5/8" + 11 7/8") / 17 3/4" + 17 3/4" / 41 3/8" (23 5/8" + 17 3/4") H 31 1/2"	W 17 3/4" - 23 5/8"	H 25 1/4" - 37 7/8"

Interior fittings for modular elements

For sideboards and TV Unit **Cabaret - Incontro - Lampo - Scrigno**

INTERNAL COMPARTMENTS FOR LAMPO BASE UNITS

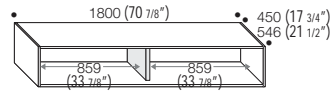
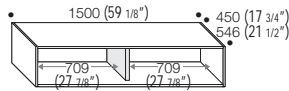
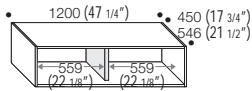

OPTIONAL INTERNAL DRAWERS FOR SIDEBOARDS WITH HINGED DOOR UNITS W 23 5/8"

The sideboards provide for insertion of an internal four sided fully pull-out folding drawer, applicable to units of width 23 5/8" depth 17 3/4" - 21 1/2" with hinged doors.

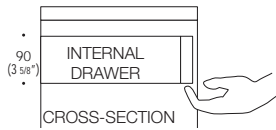

D	W	CODE
		<ul style="list-style-type: none"> Melamine finish <ul style="list-style-type: none"> - Frassinato - Bianco 10-Canapa - Olmo - Medio-Scuro - Loto - Natura-Tortora-Terra Matt lacquered Veneered oak <ul style="list-style-type: none"> - Carbone - Grigio - Cenere - Argilla - Nodato Caramello - Nodato Naturale - Termotrattato - Noce Canaletto <p>Metal lacquered</p>

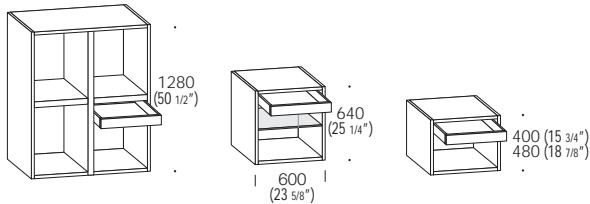

Optional internal drawer under the cover or shelf







For hinged and drop-down doors	17 3/4"/18 3/8" 23 5/8" NHC2060	167	178	178
	21 1/2"/22 1/8" 23 5/8" NHC4060	188	200	200
For drop-down doors	17 3/4"/18 3/8" 29 5/8" NHC2075	177	189	189
	21 1/2"/22 1/8" 29 5/8" NHC4075	198	213	213

Interior fittings for modular elements

For sideboards and TV Unit **Cabaret - Incontro - Lampo - Scrigno**

W	D	W	m ²	CODE				
ADDITIONAL INTERNAL GLASS SHELVES TH. 1/4" FOR UNITS WITH HINGED DOORS Additional holes on request								
 11 7/8"	FOR UNITS WITH HINGED DOORS	21 1/2"	11 7/8"	0,01	NRV8025E	22		
					17 3/4"	0,01	NRV8040E	25
					23 5/8"	0,01	NRV8055E	30
					29 5/8"	0,01	NRV8070E	33
					35 1/2"	0,01	NRV8085E	37
 17 3/4"	FOR UNITS WITH HINGED DOORS	17 3/4"	11 7/8"	0,01	NRV6025E	21		
					17 3/4"	0,01	NRV6040E	23
					23 5/8"	0,01	NRV6055E	25
					29 5/8"	0,01	NRV6070E	28
					35 1/2"	0,01	NRV6085E	32
 23 5/8"								
 29 5/8"								
 35 1/2"								

ALTERNATIVE 20 THICK WOOD SHELVES
FOR UNITS WITH HINGED DOORS

					SURCHARGE		
 11 7/8"	FOR UNITS WITH HINGED DOORS	21 1/2"	11 7/8"	0,01		+ 13	
					17 3/4"	0,01	+ 13
					23 5/8"	0,01	+ 10
					29 5/8"	0,01	+ 10
					35 1/2"	0,01	+ 10
 17 3/4"	FOR UNITS WITH HINGED DOORS	17 3/4"	11 7/8"	0,01		+ 13	
					17 3/4"	0,01	+ 14
					23 5/8"	0,01	+ 13
					29 5/8"	0,01	+ 12
					35 1/2"	0,01	+ 10
 23 5/8"							
 29 5/8"	FOR UNITS WITH HINGED DOORS	13 7/8"	11 7/8"	0,01		+ 14	
					17 3/4"	0,01	+ 12
					23 5/8"	0,01	+ 11
					29 5/8"	0,01	+ 11
					35 1/2"	0,01	+ 10

Openings for wooden doors and drawers

For sideboards and TV Unit **Incontro - Lampo - Scrigno**

"PUSH-PULL" OPENING INCLUDED IN THE PRICE OF THE UNIT



FOR DRAWERS W 17 3/4" - 23 5/8" - 35 1/2" - 47 1/4" - 59 1/8" - H 6 3/8" - 9 1/2" - 12 5/8" - 15 3/4"
 FOR HINGED WOODEN OR GLASS DOORS W 11 7/8"-17 3/4"-23 5/8" - H 12 5/8"-15 3/4"-18 7/8"-25 1/4"-37 7/8"-50 1/2"-62 7/8"
 FOR DROP-DOWN / LIFT-UP WOODEN OR GLASS DOORS W 23 5/8"-35 1/2"-47 1/4"-59 1/8"-70 7/8" - H 9 1/2"-12 5/8"-15 3/4"

PUSH-PULL OPENING

Push-Pull opening is available on all items with wooden and glass doors. For correct functioning, the air gap between the structure and front door must be 1/4".

DOORS WITH PUSH-PULL OPENING

Push the centre of the door and the side opposite the hinges.

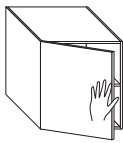

DRAWERS WITH PUSH-PULL OPENING

To ensure perfect operation for the mechanism, to open and close press the centre of the front on the side next to the guides.

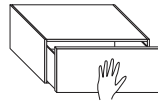

DROP-DOWN OR LIFT-UP DOORS WITH PUSH-PULL OPENING

Press the centre of the door and the side opposite the hinges.

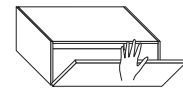

"MINIMAL" PROFILE INCLUDED IN THE PRICE OF THE UNIT

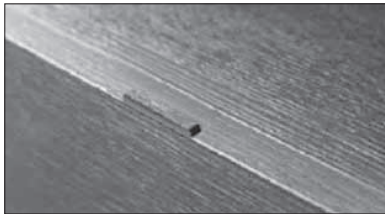

POSITION OF HANDLES

Hinged door

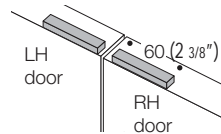

Drop-down door /Drawers
(central position on module width)

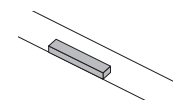

To be used on fronts of base units with finished cover and ceramic top

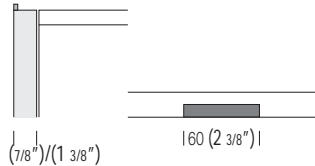

FINISHES IN COMBINATION

FINISHES FOR WOODEN FRONTS:

- OAK Carbone
- OAK Argilla
- OAK Grigio
- OAK Cenere
- ROVERE NODATO Naturale
- ROVERE NODATO Caramello
- OAK TERMOTRATTATO
- NOCE CANALETTO
- Matt/glossy LACQUERED
- Metal LACQUERED
- MELAMINE FINISH Olmo Medio
- MELAMINE FINISH Olmo Scuro
- MELAMINE FINISH Loto Natura
- MELAMINE FINISH Loto Tortora
- MELAMINE FINISH Loto Terra
- MELAMINE FINISH Frassinato Bianco 10
- MELAMINE FINISH Frassinato Canapa

MINIMAL PROFILE/SEGNO HANDLE FINISH:

- BROWN
- Matt TERRANOVA
- BROWN
- PIOMBO
- BROWN
- BROWN
- BROWN
- BROWN
- BROWN
- Matt/glossy LACQUERED
- Metal LACQUERED
- PIOMBO
- BROWN
- Matt GRIGIO CORDA
- Matt GRIGIO CORDA
- Matt TERRANOVA
- Matt BIANCO 10
- Matt CANAPA

"SEGNO" HANDLE INCLUDED IN THE PRICE OF THE UNIT

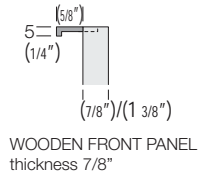
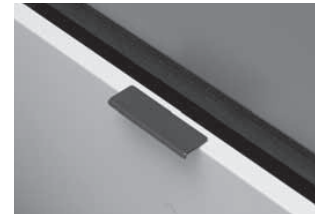

WOODEN FRONT PANEL thickness 7/8"

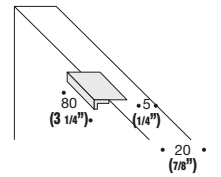

Handle built into the edge

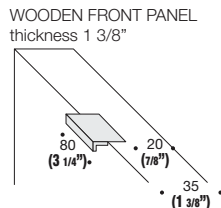

WOODEN FRONT PANEL thickness 1 3/8"

POSITIONING DIAGRAM FOR SEGNO AND ASSISA HANDLES

Wooden drawers and deep drawers

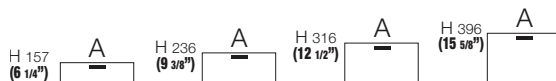

Wooden drop-down doors

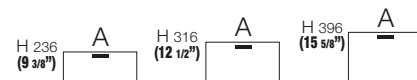

Wooden hinged doors

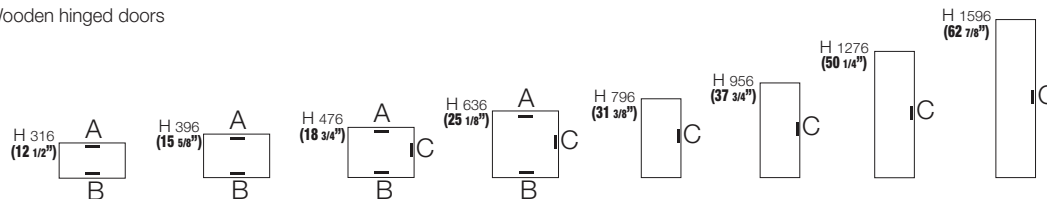

Openings for wooden doors and drawers

For sideboards and TV Unit **Lampo - Scrigno - Incontro - Open**

“ASSISA” HANDLE

INCLUDED IN THE PRICE OF THE UNIT (FOR WOODEN FRONT PANELS)



FINISHES:

- Metal chrome finish, matt lacquered and gloss lacquer

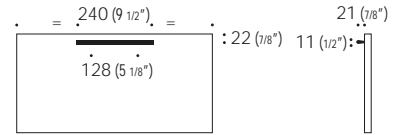

W 9 1/2" – distance between holes 5 1/8"

“STAR” HANDLE WITH SURCHARGE

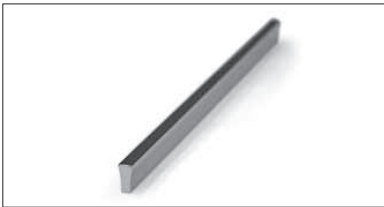

FINISHES:

- Metal chrome finish, matt lacquered and gloss lacquer

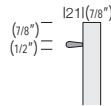

SURCHARGE	
-----------	--

For front W 17 3/4"	+8
For front W 23 5/8"	+10
For front W 35 1/2"	+14
For front W 47 1/4"	+17
For front W 59 1/8"	+20
For front W 70 7/8"	+23

“Star” handle position on the doors

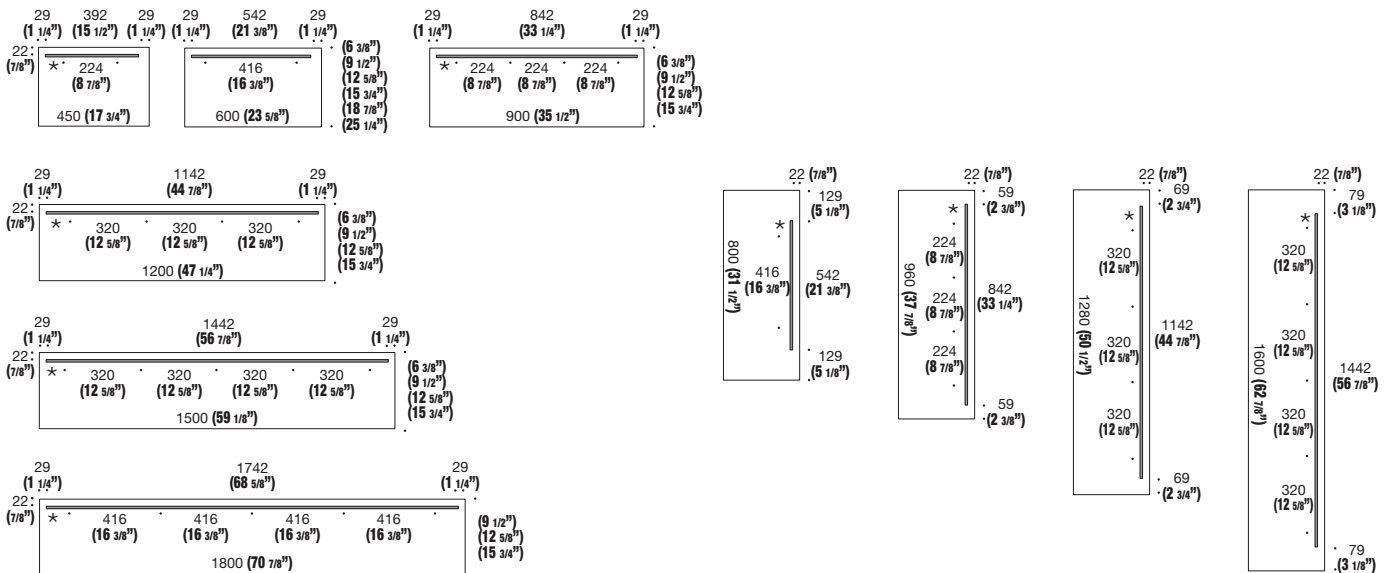

* Distance between holes

Fronts

For sideboards and TV Unit **Cabaret - Incontro - Lampo - Scrigno**

Below are the prices of doors and drawers for the Lampo units used to make up LAMPO, INCONTRO, SCRIGNO and CABARET sideboards and TV units. These should be used to calculate the price of containers with finishing fronts or thicknesses different from those included in the price list compositions. For any other modifications (e.g. changing type of opening) contact the sales office to check feasibility and find the relative price.

EXAMPLE:

Cabaret 9B

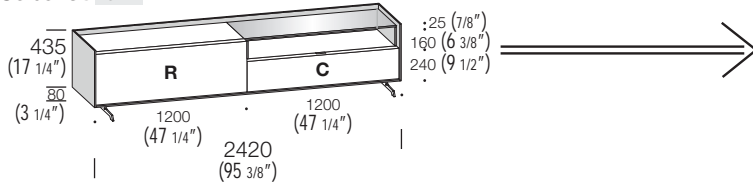

PRICE LIST compositions

	Melamine finish
Drop-down door W 47 1/4" H 15 3/4"	142
Drawer W 47 1/4" H 9 1/2"	124
	266

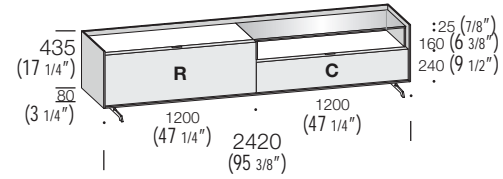

NEW composition

	Melamine finish carcass Metal lacquered fronts
Drop-down door W 47 1/4" H 15 3/4"	227
Drawer W 47 1/4" H 9 1/2"	184
	411

The composition with the new finishes costs € 145 extra.

Cabaret 26A

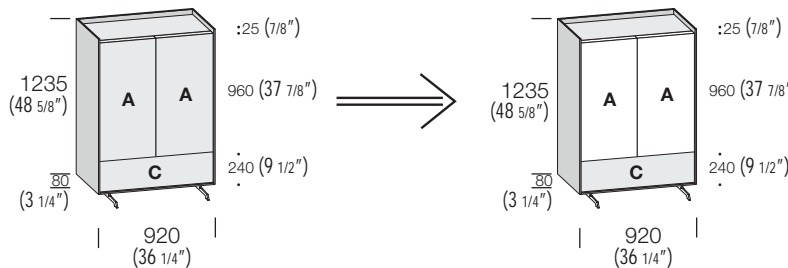

	Veneered oak	Matt lacquered
Doors W 17 3/4" H 37 7/8"	103x2	87x2
	206	174

The composition with lacquered fronts costs € 32 less than the one entirely veneered

Incontro 504

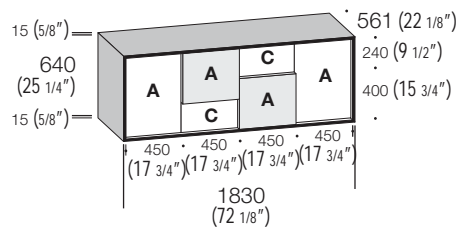

PRICE LIST compositions

Veneered	Matt lacquered
Frame 4 sides	Fronts Th. 7/8"
Fronts Th. 1 3/8"	
Internal carcass	

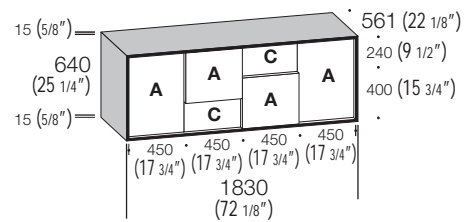

NEW composition

Veneered	Matt lacquered
Frame 4 sides	Fronts Th. 1 3/8"
Internal carcass	Fronts Th. 7/8"

	Veneered oak	Matt lacquered
Doors W 17 3/4" H 15 3/4" TH 1 3/8"	80x2	64x2

Price difference € 32