

GREGORY

STANDARD FEATURES

- Hard wood frame, seat suspensions in reinforced elastic webbing.
- Seat depth 68 cm - 27".
- Seat height 43 cm - 17".
- Armrest width 29 cm - 11".
- Armrest height 55 cm - 22".
- Seat cushions in polyurethane covered with wadding.
- Back cushions in feather with insert in polyurethane.
- Folding bed not available.
- Wood legs height 4 cm - 1 1/2".
- Stitching CUC 503B.

CARATTERISTICHE STANDARD

- Struttura in legno e multistrato, molleggio seduta con cinghie elastiche.
- Profondità seduta 68 cm.
- Altezza seduta 43 cm.
- Larghezza braccio 29 cm.
- Altezza braccio 55 cm.
- Cuscini seduta in poliuretano rivestiti in falda.
- Cuscini schienale in piuma con inserto in poliuretano.
- Inserimento letto non possibile.
- Piedi in legno altezza 4 cm.
- Cucitura CUC 503B.

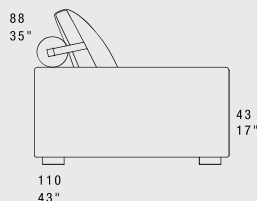

D2M
228 / 90"

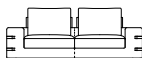

D3
258 / 102"

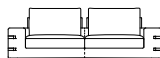

S43
254 / 100"



D43
254 / 100"

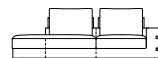

- THE BELTS AND FLAT PIPING ARE ALWAYS IN LEATHER

- IN THE FABRIC VERSION THE ROLL CUSHION IS IN LEATHER WITH FABRIC SIDES

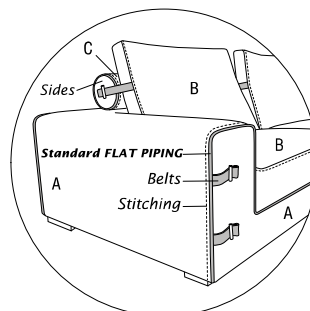

Y

all items in group Y have the same seat width / tutti gli elementi del gruppo Y hanno lo stesso modulo di seduta

E10
85 / 33"



E14
170 / 67"



S12
114 / 45"



D12
114 / 45"



S02
199 / 78"

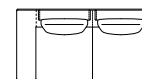

D02
199 / 78"

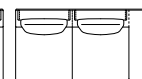

S16
140 / 55"

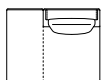

D16
140 / 55"

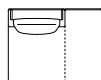

S18
225 / 89"

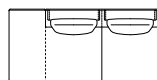

D18
225 / 89"

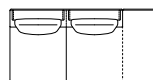

S04
268 / 106"

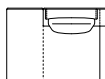

D04
268 / 106"

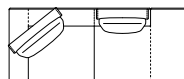

CHLY
85 / 33"

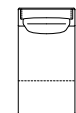

S30
114 / 45"

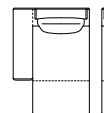

D30
114 / 45"

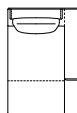

DEPTH 160 / 63"

NOTES

- Dimensions: the first figure shows sizes in centimeters, the second in inches.
- Mixing above groups (Y - J) will create sectionals with different seat widths.
- Corner pieces S/D01, E37, S/D81 and S/DCC are odd pieces and can be used with all above groups Y - J.
- EBC Storage arm, inner dimensions 7" x H 13" x 28".
- Suggested pillows C0202 and C0203.
- Please advise covers for A, B and C.
- EV4, EV2 and C0203 Standard with tufting

NOTE

- Dimensioni: la prima cifra indica i centimetri, la seconda cifra indica i pollici.
- Utilizzando elementi di famiglie diverse (Y - J) si avranno composizioni con sedute di larghezza diverse tra di loro.
- Gli elementi S/D01, E37, S/D81 e S/DCC possono essere utilizzati indifferentemente con i gruppi Y - J.
- Braccio contenitore EBC, interno 18 x H 32,5 x 72 cm.
- Cuscini consigliati C0202 e C0203.
- Si prega di specificare i rivestimenti A, B e C.
- EV4, EV2 and C0203 con trapuntatura standard.

J

all items in group J have the same seat width / tutti gli elementi del gruppo J hanno lo stesso modulo di seduta

E11
100 / 39"



E15
200 / 79"

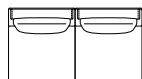

S13
129 / 51"



D13
129 / 51"



S03
229 / 90"

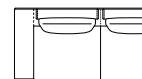

D03
229 / 90"

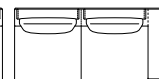

S17
155 / 61"

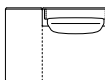

D17
155 / 61"

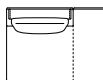

S19
255 / 100"

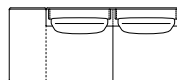

D19
255 / 100"

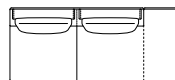

CHLJ
100 / 39"



S31
129 / 51"

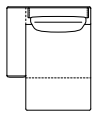

D31
129 / 51"

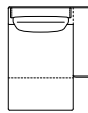

DEPTH 160 / 63"

S01
128 / 50"

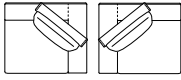

D01
128 / 50"

E37
209X145 / 82X57"

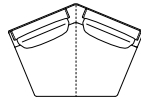

S81
232X196 / 91X77"

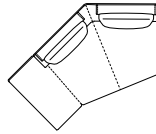

D81
232X196 / 91X77"

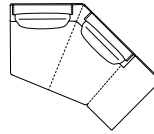

**CHAISE LONGUE WITH
STORAGE ARM**

SCC **DCC**
110 / 43" 110 / 43"

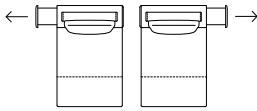

DEPTH 170 / 67"

STORAGE ARM

EBC
36X110XH.55 / 14X43XH.22"

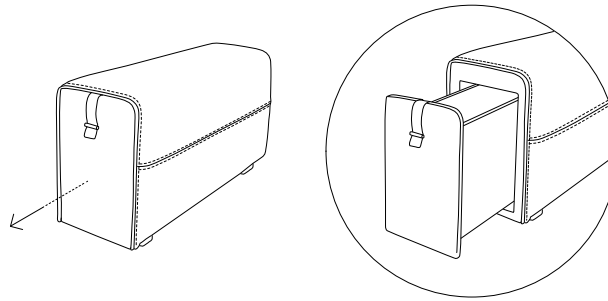

INNER DIMENSIONS :
18X72XH.32,5 / 7X28XH.13"

EV4
110X110XH.43 / 43X43XH.17"

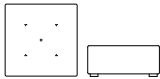

EV2 FOOTSTOOL
110X65XH.43 / 43X26XH.17"

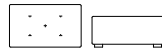

C0202 SUGGESTED LUMBAR PILLOW
67X30 / 26X12"

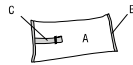

C0203 SUGGESTED PILLOW
60X60 / 24X24"



**EV4, EV2 AND C0203
STANDARD WITH TUFTING**